

Part number

MKA AP20



Brief description:

angled bulkhead housings with single lever, size "21.21", with threaded entry, bottom closed, M20, metal version, IP44, IP66/IP67 degree of protection with CKR 65 kit or CKR 65 D kit.

Product description

Version	Metallic type
Series	Angled mounting housings with 1 lever
Product type	with 1 lever in galvanised steel
Variant	with threaded entry, bottom closed
Family	CKA metal enclosures
Size	size "21.21"

Technical data

Operating temperature range (min, max)	-40°C ... +125°C
Material	metal
IP degree of protection	IP44 (IP66/IP67 with CKR 65/CKR 65 D kits)
Cable entry	M20

Further technical details

Weight	34,00 g
---------------	---------

Approvals / Standards

Quality mark	UL type: 12, (type 4/4X only with kit CKR 65 or CKR 65 D),  , EAC
Conformity	CQC, CE

General ordering information

EAN13 code	8015747152877
Tariff number	85369095

Packaging Information

Sub-packaging length	140,00 mm
Sub-packaging height	66,00 mm
Sub-packaging width	150,00 mm
Sub-packaging weight	0,34 kg
Sub-packaging volume	1,39 dm ³
Sub-packaging description	Carton Box
Sub-packaging quantity	10 Pcs
Sub-packaging EAN barcode	8015747172752

Part number

MKA AP20



Catalogue drawings

Catalogue drawings

CKA IA

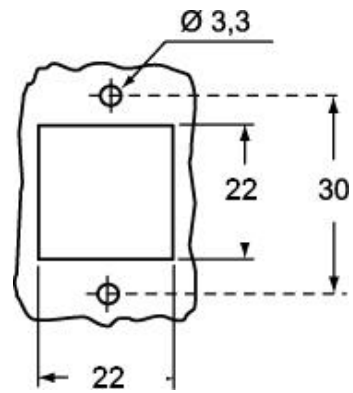
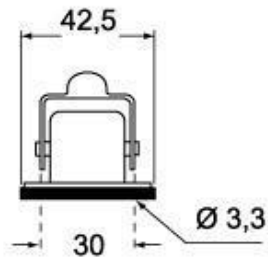
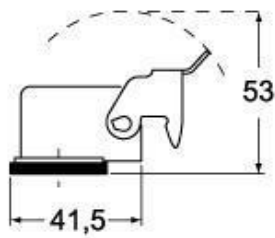

CKAX IA

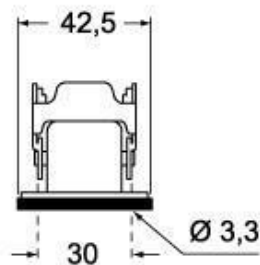
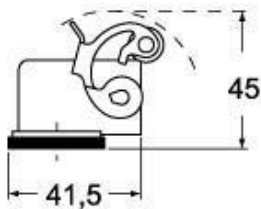

CKA IAPS (CKA APS) MKA - IAP (MKA AP)

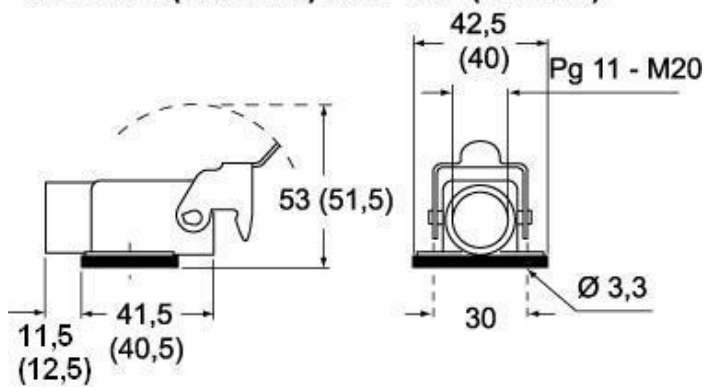

CKAX IAPS (CKAX APS) - MKAX IAP (MKAX AP)

